

**Maintainer** Custom Bodies, Inc. [mcbfire.com](http://mcbfire.com)  
 909 South East Street (800) 843-4288 Toll Free  
 Rock Rapids, IA 51246 (712) 472-4725

|                            |                              |             |  |
|----------------------------|------------------------------|-------------|--|
| CUSTOMER APPROVED BY:      |                              | PAINT CODE: |  |
| VEHICLE TYPE: HEAVY RESCUE | CHASSIS: CUSTOMER'S GMC 7500 |             |  |
| VIEW: STREETSIDE           | BODY MAT'L: ALUMINUM         |             |  |
| SCALE: NTS                 | BODY LENGTH: 192'            |             |  |
| DRAWN BY: NRW              | APPROVED BY:                 |             |  |
| DATE: 3/9/2020             | BODY STYLE:                  |             |  |
| DWG NO.: NEWMANGROVENE     | REVISION:                    |             |  |

NEWMAN GROVE, NEBRASKA FIRE DEPARTMENT

NOTE: ALL DIMENSIONS ARE APPROXIMATE

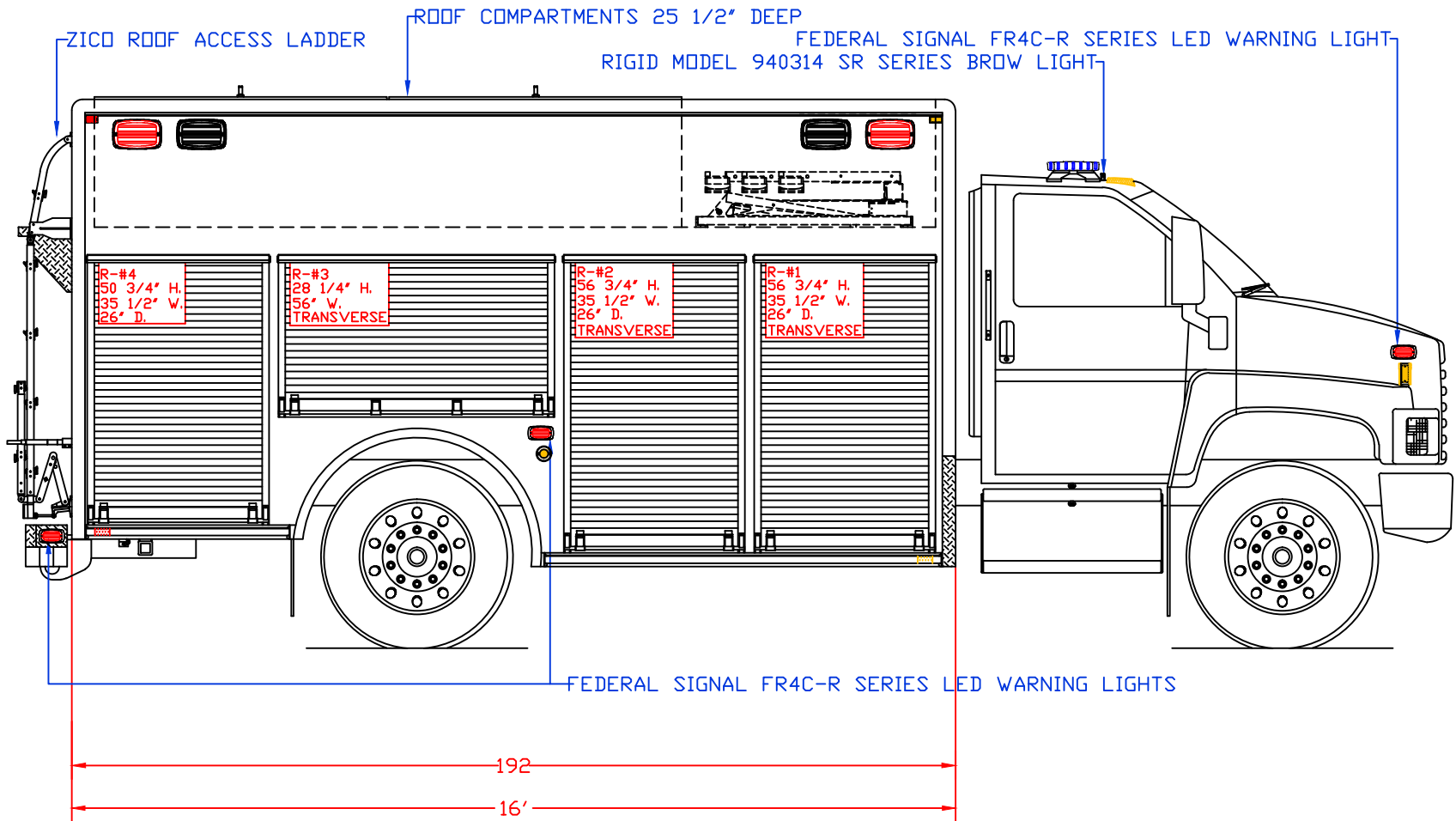

**Maintainer** Custom Bodies, Inc. [mcbfire.com](http://mcbfire.com)  
 909 South East Street (800) 843-4288 Toll Free  
 Rock Rapids, IA 51246 (712) 472-4725

CUSTOMER APPROVED BY: \_\_\_\_\_ PAINT CODE: \_\_\_\_\_

|                            |                              |
|----------------------------|------------------------------|
| VEHICLE TYPE: HEAVY RESCUE | CHASSIS: CUSTOMER'S GMC 7500 |
| VIEW: CURBSIDE             | BODY MAT'L: ALUMINUM         |
| SCALE: NTS                 | BODY LENGTH: 192'            |
| DRAWN BY: NRW              | APPROVED BY: _____           |
| DATE: 3/9/2020             | BODY STYLE: _____            |
| DWG NO.: NEWMANGROVENE     | REVISION: _____              |

NEWMAN GROVE, NEBRASKA FIRE DEPARTMENT

NOTE: ALL DIMENSIONS ARE APPROXIMATE

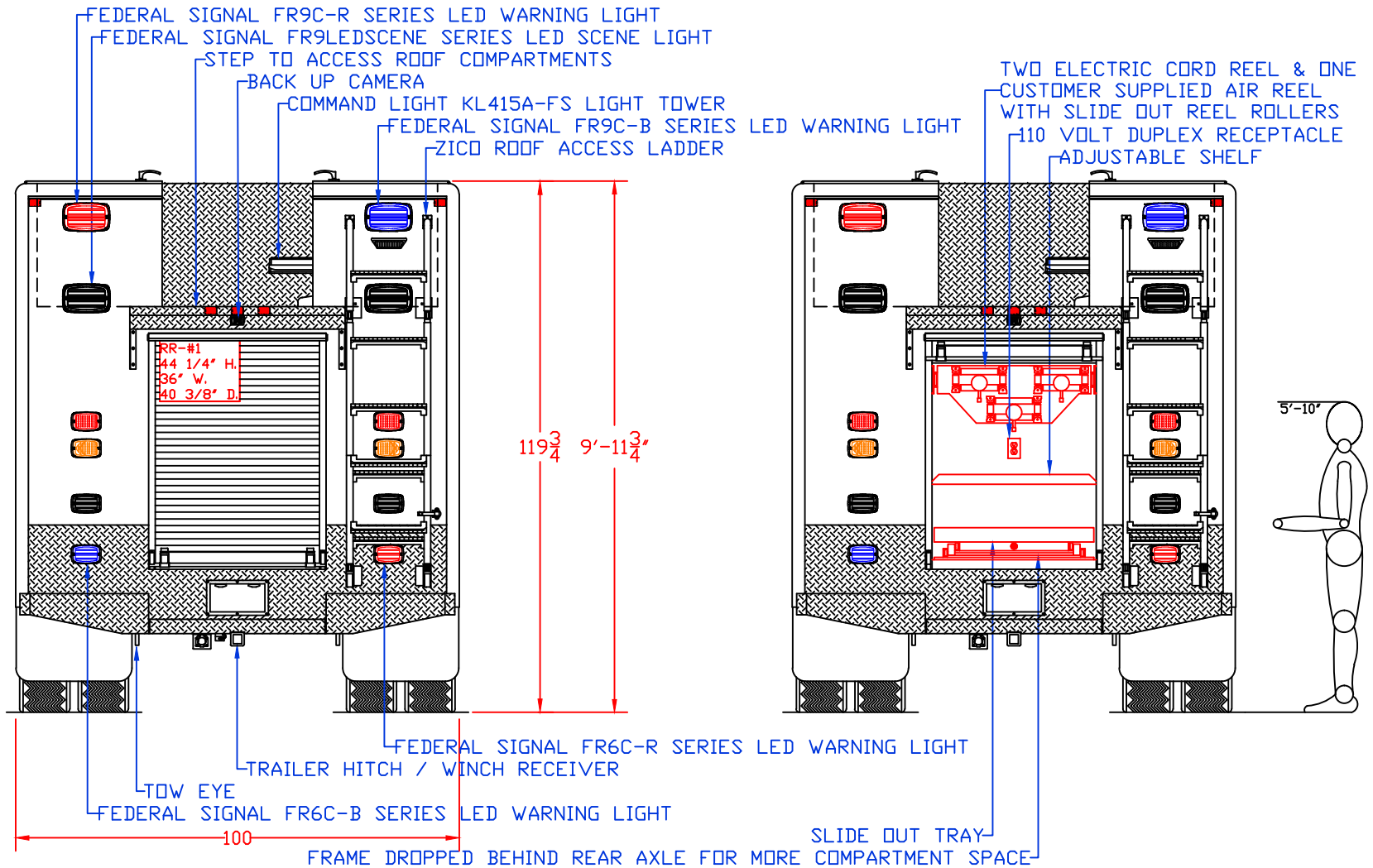

**Maintainer** Custom Bodies, Inc.  
 909 South East Street  
 Rock Rapids, IA 51246

mcbfire.com  
 (800) 843-4288 Toll Free  
 (712) 472-4725

|                                      |                              |             |  |
|--------------------------------------|------------------------------|-------------|--|
| CUSTOMER APPROVED BY:                |                              | PAINT CODE: |  |
| VEHICLE TYPE: HEAVY RESCUE           | CHASSIS: CUSTOMER'S GMC 7500 |             |  |
| VIEW: REAR & REAR COMPARTMENT LAYOUT | BODY MAT'L: ALUMINUM         |             |  |
| SCALE: NTS                           | BODY LENGTH: 192'            |             |  |
| DRAWN BY: NRW                        | APPROVED BY:                 |             |  |
| DATE: 3/9/2020                       | BODY STYLE:                  |             |  |
| DWG NO.: NEWMANGROVENE               | REVISION:                    |             |  |

NEWMAN GROVE, NEBRASKA FIRE DEPARTMENT

NOTE: ALL DIMENSIONS ARE APPROXIMATE

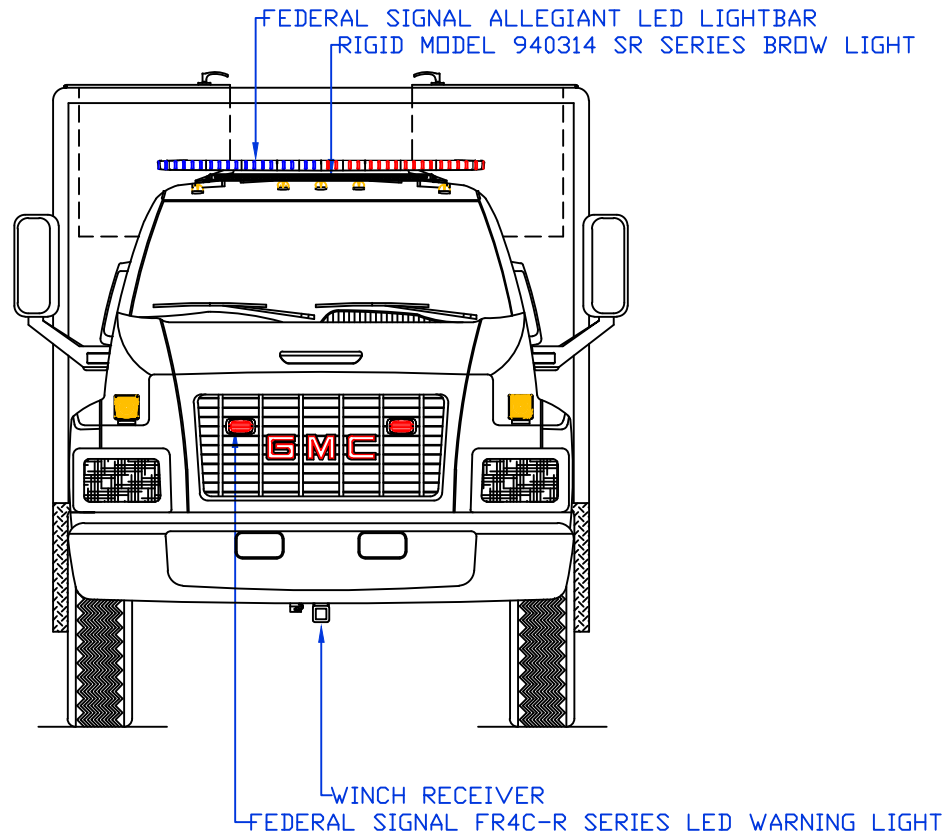

**Maintainer** Custom Bodies, Inc.  
 909 South East Street  
 Rock Rapids, IA 51246

mcbfire.com

(800) 843-4288 Toll Free  
 (712) 472-4725

|                            |                              |                                      |                   |
|----------------------------|------------------------------|--------------------------------------|-------------------|
| CUSTOMER APPROVED BY:      |                              | PAINT CODE:                          |                   |
| VEHICLE TYPE: HEAVY RESCUE | CHASSIS: CUSTOMER'S GMC 7500 | BODY MAT'L: ALUMINUM                 | BODY LENGTH: 192" |
| VIEW: FRONT                | SCALE: NTS                   | DRAWN BY: NRW                        | DATE: 3/9/2020    |
| DWG NO.: NEWMANGROVENE     | REVISION:                    | NOTE: ALL DIMENSIONS ARE APPROXIMATE |                   |

NEWMAN GROVE, NEBRASKA FIRE DEPARTMENT

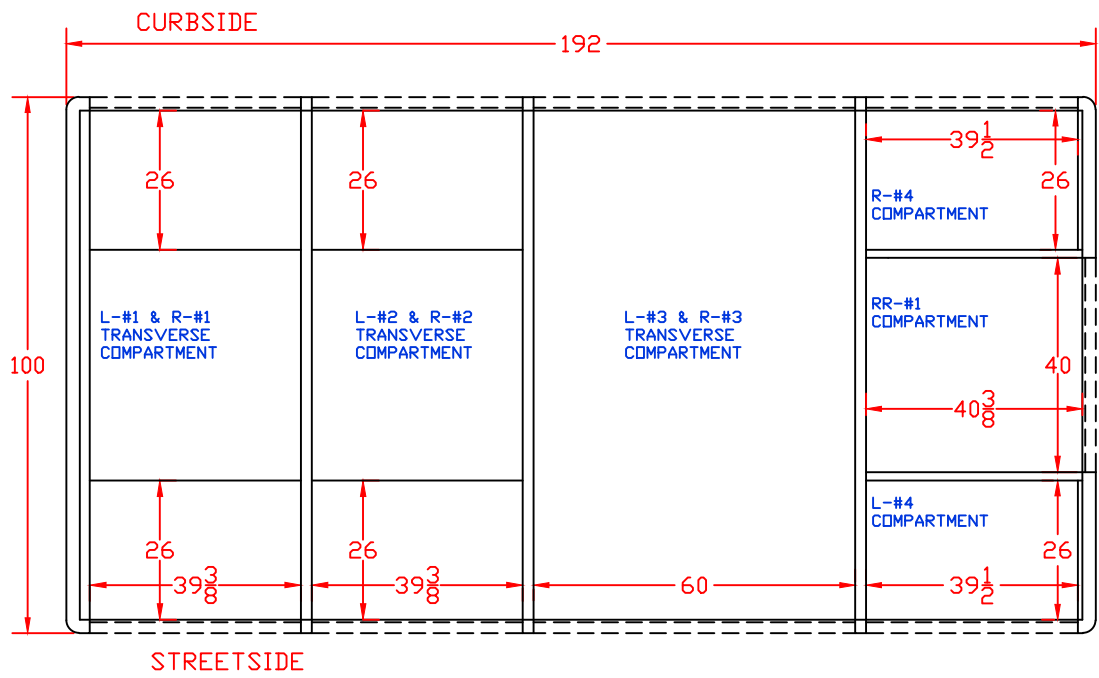

**Maintainer** *Custom Bodies, Inc.*  
 909 South East Street (800) 843-4288 Toll Free  
 Rock Rapids, IA 51246 (712) 472-4725

[mcbfire.com](http://mcbfire.com)

CUSTOMER APPROVED BY:

PAINT CODE:

VEHICLE TYPE: HEAVY RESCUE

CHASSIS: CUSTOMER'S GMC 7500

VIEW: TOP

BODY MAT'L: ALUMINUM

SCALE: NTS

BODY LENGTH: 192"

DRAWN BY: NRW

APPROVED BY:

DATE: 3/9/2020

BODY STYLE:

DWG NO.: NEWMANGROVENE

REVISION:

NEWMAN GROVE, NEBRASKA FIRE DEPARTMENT

NOTE: ALL DIMENSIONS ARE APPROXIMATE

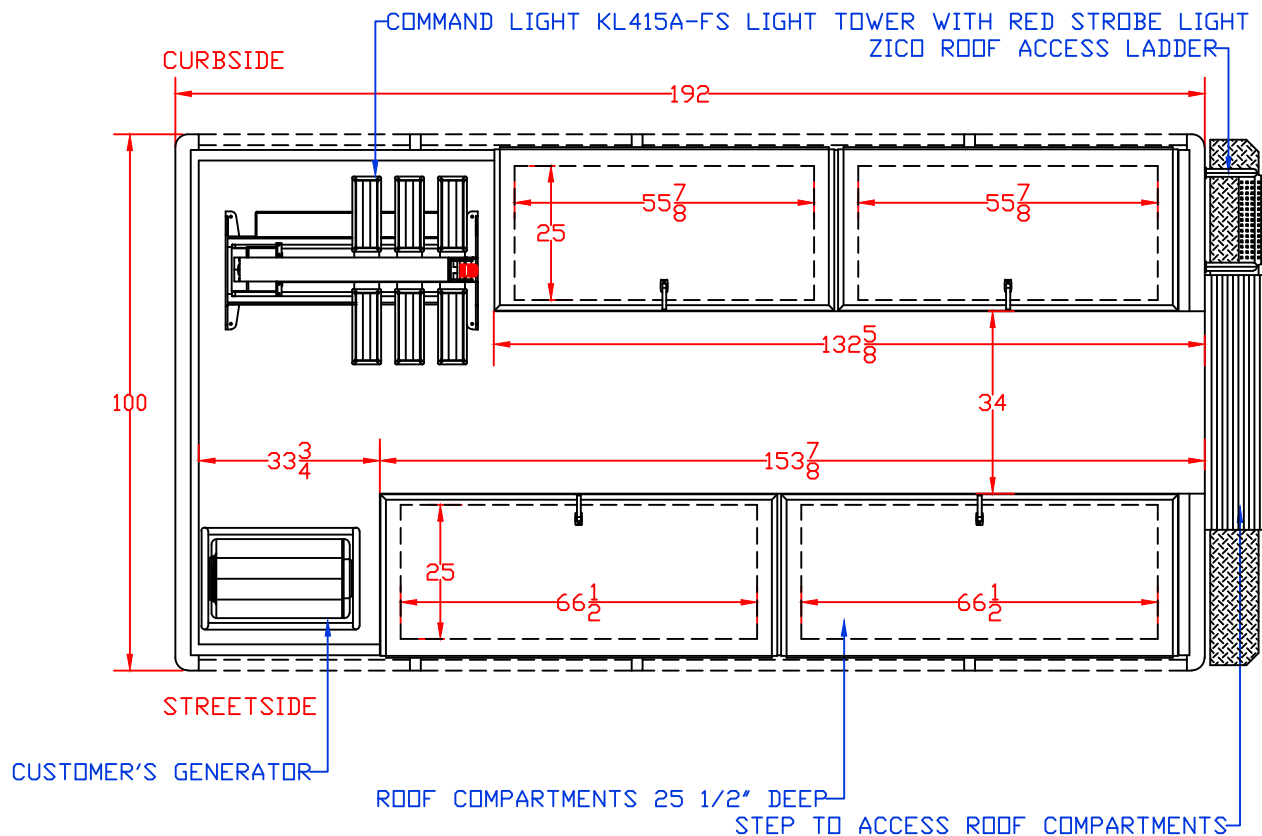

**Maintainer** *Custom Bodies, Inc.*  
 909 South East Street  
 Rock Rapids, IA 51246  
 mcbfire.com  
 (800) 843-4288 Toll Free  
 (712) 472-4725

CUSTOMER APPROVED BY: \_\_\_\_\_ PAINT CODE: \_\_\_\_\_

|                            |                              |
|----------------------------|------------------------------|
| VEHICLE TYPE: HEAVY RESCUE | CHASSIS: CUSTOMER'S GMC 7500 |
| VIEW: ROOF                 | BODY MAT'L: ALUMINUM         |
| SCALE: NTS                 | BODY LENGTH: 192"            |
| DRAWN BY: NRW              | APPROVED BY: _____           |
| DATE: 3/9/2020             | BODY STYLE: _____            |
| DWG NO.: NEWMANGROVENE     | REVISION: _____              |

NEWMAN GROVE, NEBRASKA FIRE DEPARTMENT

NOTE: ALL DIMENSIONS ARE APPROXIMATE

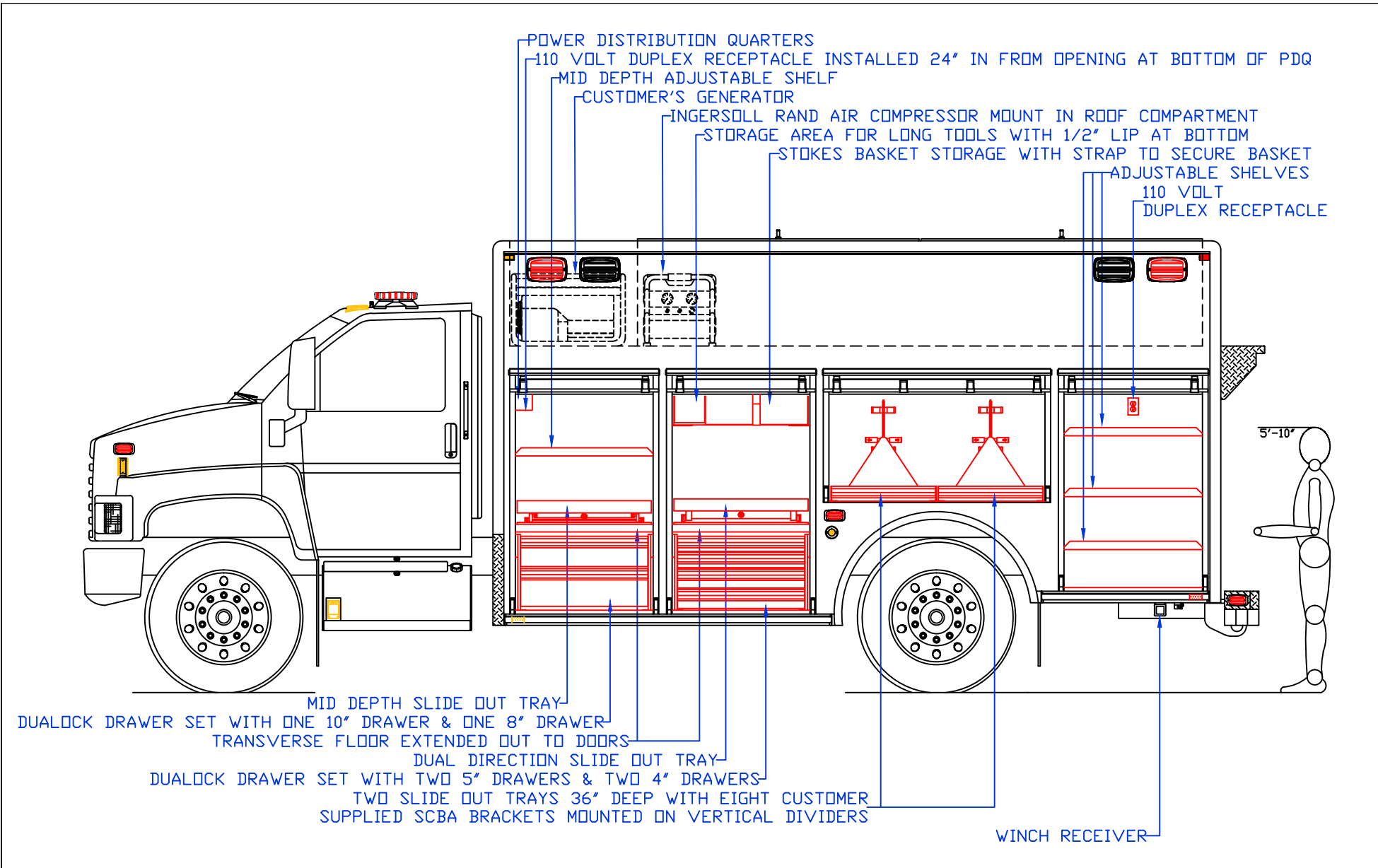

**Maintainer** Custom Bodies, Inc. [mcbfire.com](http://mcbfire.com)  
 909 South East Street (800) 843-4288 Toll Free  
 Rock Rapids, IA 51246 (712) 472-4725

|                                     |                              |                      |  |
|-------------------------------------|------------------------------|----------------------|--|
| CUSTOMER APPROVED BY:               |                              | PAINT CODE:          |  |
| VEHICLE TYPE: HEAVY RESCUE          | CHASSIS: CUSTOMER'S GMC 7500 | BODY MAT'L: ALUMINUM |  |
| VIEW: STREETSIDE COMPARTMENT LAYOUT | BODY LENGTH: 192"            |                      |  |
| SCALE: NTS                          | APPROVED BY:                 |                      |  |
| DRAWN BY: NRW                       | BODY STYLE:                  |                      |  |
| DATE: 3/9/2020                      | REVISION:                    |                      |  |
| DWG NO.: NEWMANGROVENE              |                              |                      |  |

NEWMAN GROVE, NEBRASKA FIRE DEPARTMENT

NOTE: ALL DIMENSIONS ARE APPROXIMATE

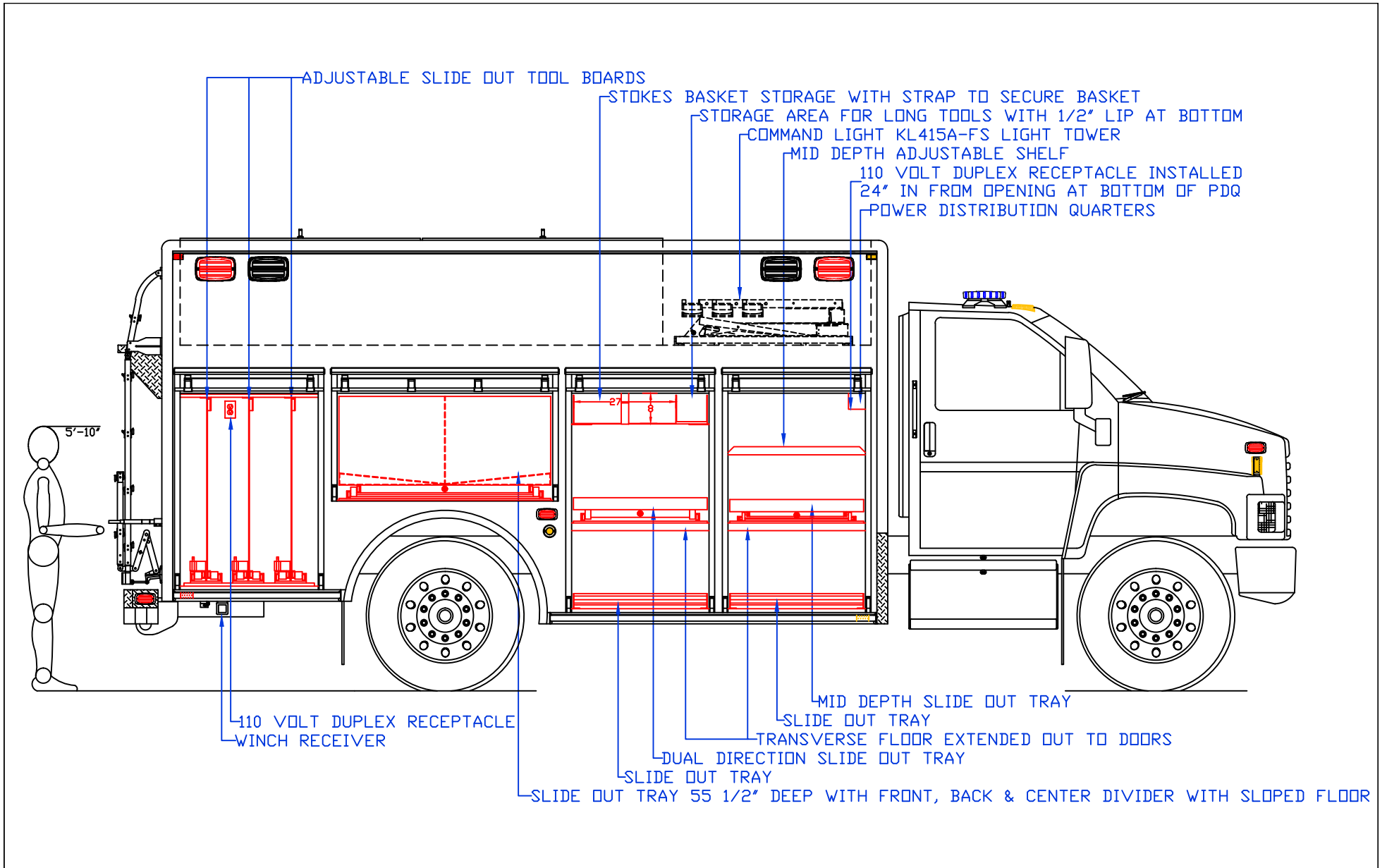

**Maintainer Custom Bodies, Inc.**  
 909 South East Street  
 Rock Rapids, IA 51246  
 mcbfire.com  
 (800) 843-4288 Toll Free  
 (712) 472-4725

|                                   |                              |                      |  |
|-----------------------------------|------------------------------|----------------------|--|
| CUSTOMER APPROVED BY:             |                              | PAINT CODE:          |  |
| VEHICLE TYPE: HEAVY RESCUE        | CHASSIS: CUSTOMER'S GMC 7500 | BODY MAT'L: ALUMINUM |  |
| VIEW: CURBSIDE COMPARTMENT LAYOUT | BODY LENGTH: 192'            | APPROVED BY:         |  |
| SCALE: NTS                        | DATE: 3/9/2020               | BODY STYLE:          |  |
| DRAWN BY: NRW                     | DWG NO.: NEWMANGROVENE       | REVISION:            |  |

NEWMAN GROVE, NEBRASKA FIRE DEPARTMENT

NOTE: ALL DIMENSIONS ARE APPROXIMATE



NEWMAN GROVE FIRE DEPARTMENT R-#3 COMPARTMENT SLIDE OUT TRAY FOR CRIBBING

