

**Maintainer** mcbfire.com  
**Custom Bodies, Inc.**  
 909 South East Street  
 Rock Rapids, IA 51246  
 (800) 843-4288 Toll Free  
 (712) 472-4725

CUSTOMER APPROVED BY:		PAINT CODE:	
VEHICLE TYPE: INVESTIGATIVE	CHASSIS: FORD F-350 SUPER CAB 4X4		
VIEW: STREETSIDE	BODY MAT'L: ALUMINUM		
SCALE: NTS	BODY LENGTH: 108 1/8"		
DRAWN BY: NRW	APPROVED BY:		
DATE: 9/26/2019	BODY STYLE:		
DWG NO.: BARSTOWFIREDEPT	REVISION:		

BARSTOW FIRE DEPARTMENT SQUAD

NOTE: ALL DIMENSIONS ARE APPROXIMATE

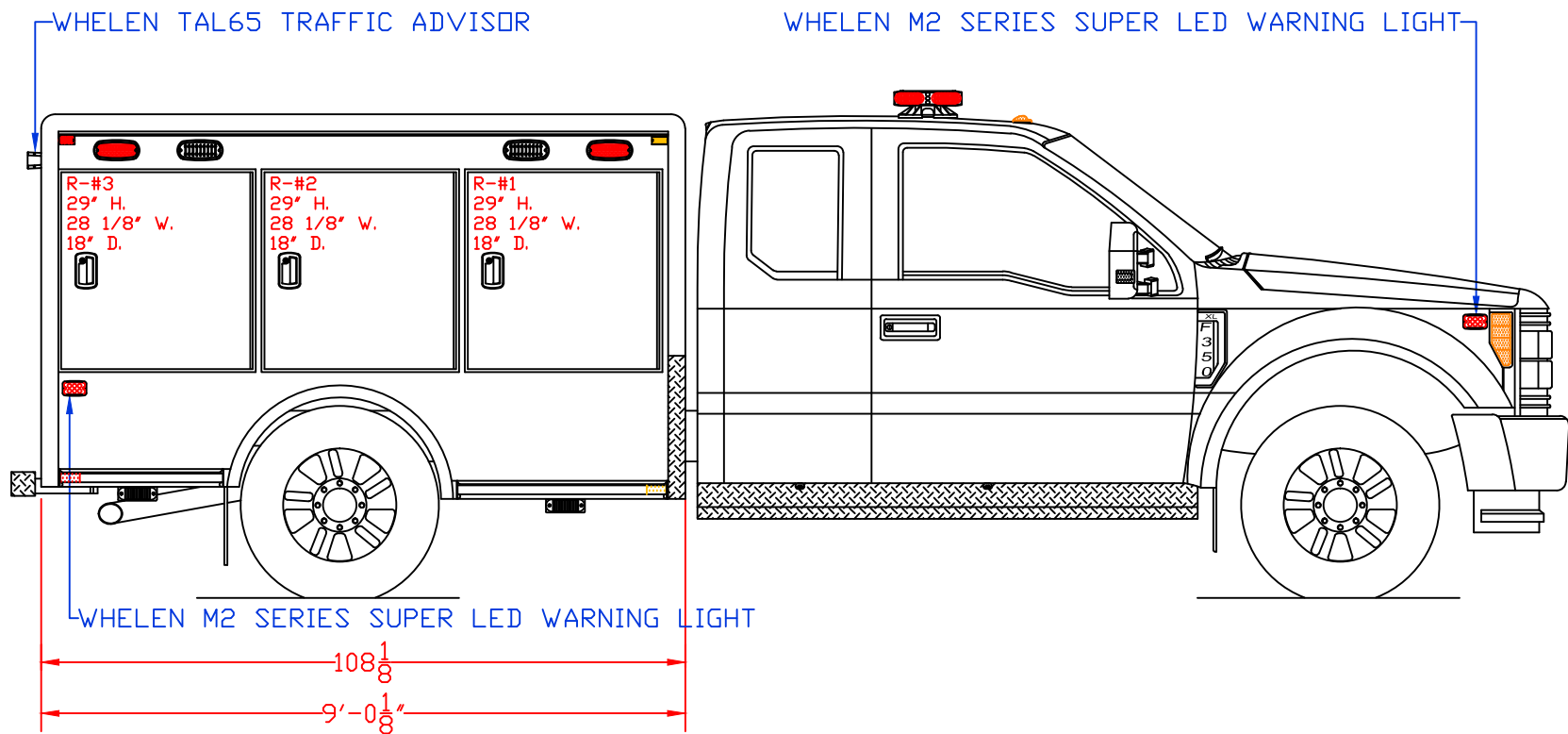

**Maintainer** [mcbfire.com](http://mcbfire.com)  
**Custom Bodies, Inc.**  
 909 South East Street (800) 843-4288 Toll Free  
 Rock Rapids, IA 51246 (712) 472-4725

BARSTOW FIRE DEPARTMENT SQUAD

CUSTOMER APPROVED BY:		PAINT CODE:	
VEHICLE TYPE: INVESTIGATIVE	CHASSIS: FORD F-350 SUPERCAB 4X4		
VIEW: CURBSIDE	BODY MAT'L: ALUMINUM		
SCALE: NTS	BODY LENGTH: 108 1/8"		
DRAWN BY: NRW	APPROVED BY:		
DATE: 9/26/2019	BODY STYLE:		
DWG NO.: BARSTOWFIREDEPT	REVISION:		

NOTE: ALL DIMENSIONS ARE APPROXIMATE

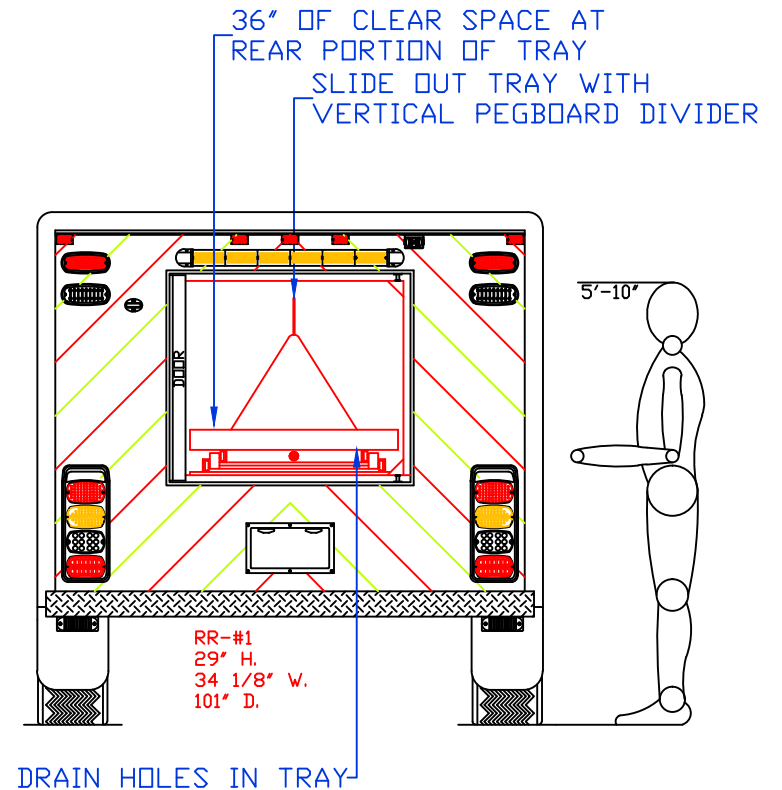
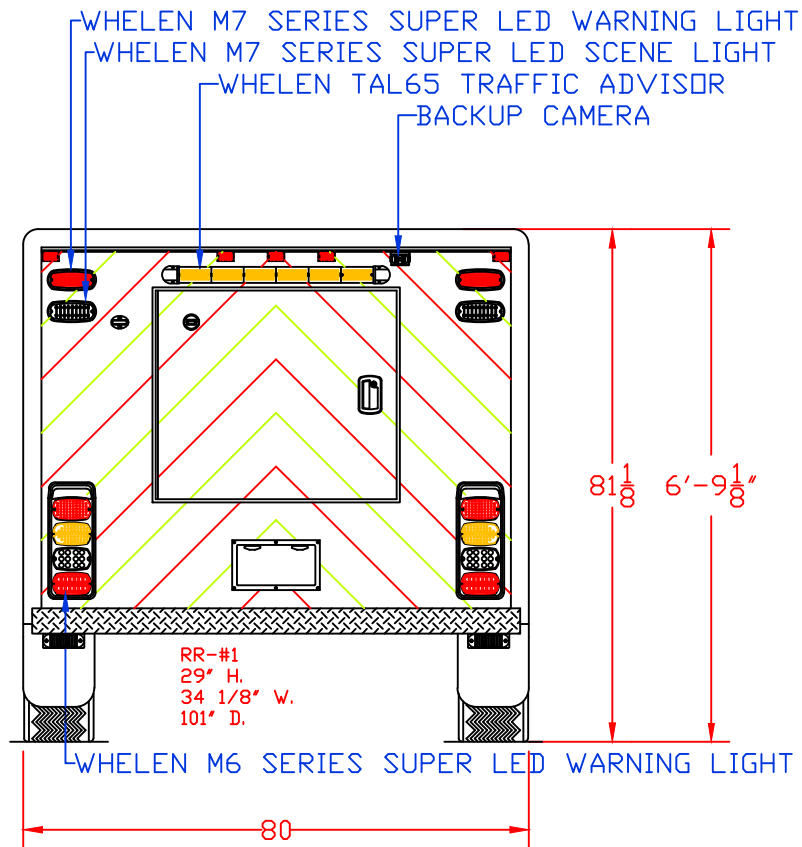

**Maintainer** mcbfire.com  
**Custom Bodies, Inc.**  
 909 South East Street (800) 843-4288 Toll Free  
 Rock Rapids, IA 51246 (712) 472-4725

BARSTOW FIRE DEPARTMENT SQUAD

CUSTOMER APPROVED BY:		PAINT CODE:	
VEHICLE TYPE: INVESTIGATIVE	CHASSIS: FORD F-350 SUPERCAB 4X4		
VIEW: REAR & REAR COMPARTMENT LAYOUT	BODY MAT'L: ALUMINUM		
SCALE: NTS	BODY LENGTH: 108 1/8"		
DRAWN BY: NRW	APPROVED BY:		
DATE: 9/26/2019	BODY STYLE:		
DWG NO.: BARSTOWFIREDEPT	REVISION:		

NOTE: ALL DIMENSIONS ARE APPROXIMATE

WHELEN LIBERTY II SERIES IG2RRRR SUPER LED LIGHTBAR

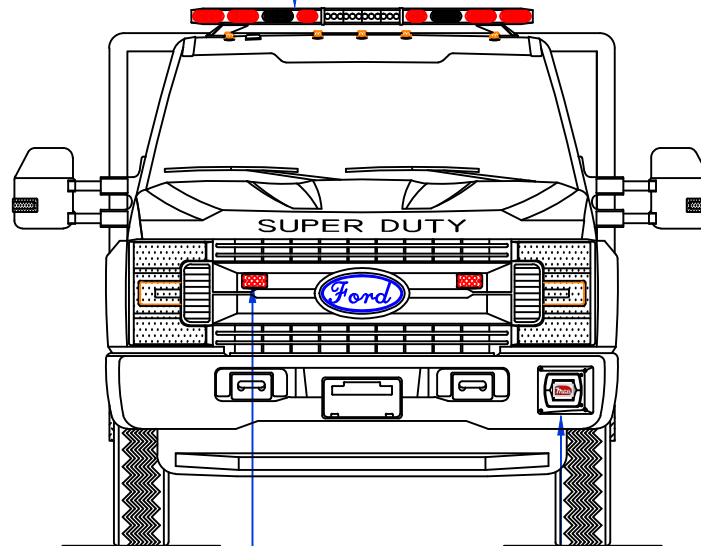

WHELEN M2 SUPER LED WARNING LIGHT

100 WATT SPEAKER



**Maintainer** mcbfire.com  
**Custom Bodies, Inc.**  
 909 South East Street (800) 843-4288 Toll Free  
 Rock Rapids, IA 51246 (712) 472-4725

<b>CUSTOMER APPROVED BY:</b>		<b>PAINT CODE:</b>
VEHICLE TYPE: INVESTIGATIVE	CHASSIS: FORD F-350 SUPERCAB 4X4	
VIEW: FRONT	BODY MAT'L: ALUMINUM	
SCALE: NTS	BODY LENGTH: 108 1/8"	
DRAWN BY: NRW	APPROVED BY:	
DATE: 9/26/2019	BODY STYLE:	
DWG NO.: BARSTOWFIREDEPT	REVISION:	

BARSTOW FIRE DEPARTMENT SQUAD

NOTE: ALL DIMENSIONS ARE APPROXIMATE

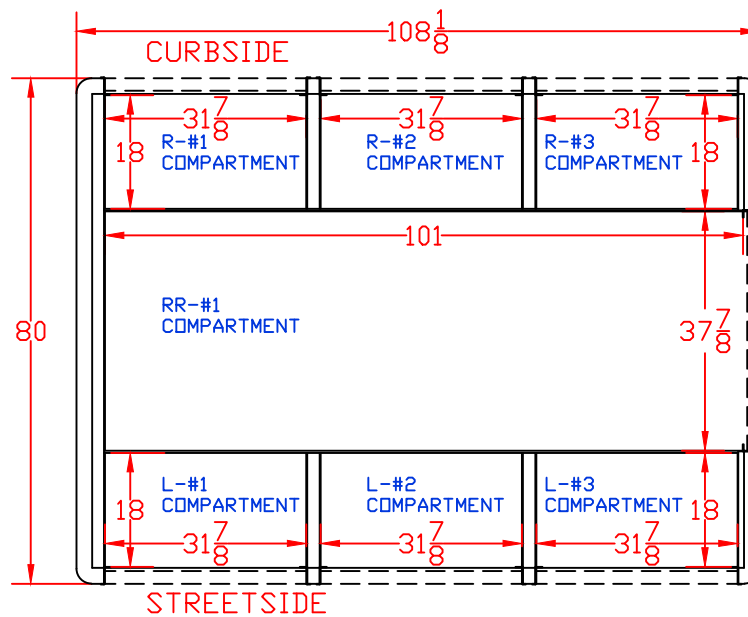

**Maintainer** mcbfire.com  
**Custom Bodies, Inc.**  
 909 South East Street (800) 843-4288 Toll Free  
 Rock Rapids, IA 51246 (712) 472-4725

CUSTOMER APPROVED BY: \_\_\_\_\_ PAINT CODE: \_\_\_\_\_

VEHICLE TYPE: INVESTIGATIVE	CHASSIS: FORD F-350 SUPERCAB 4X4
VIEW: TOP	BODY MAT'L: ALUMINUM
SCALE: NTS	BODY LENGTH: 108 1/8"
DRAWN BY: NRW	APPROVED BY: _____
DATE: 9/26/2019	BODY STYLE: _____
DWG NO.: BARSTOWFIREDEPT	REVISION: _____

BARSTOW FIRE DEPARTMENT SQUAD

NOTE: ALL DIMENSIONS ARE APPROXIMATE

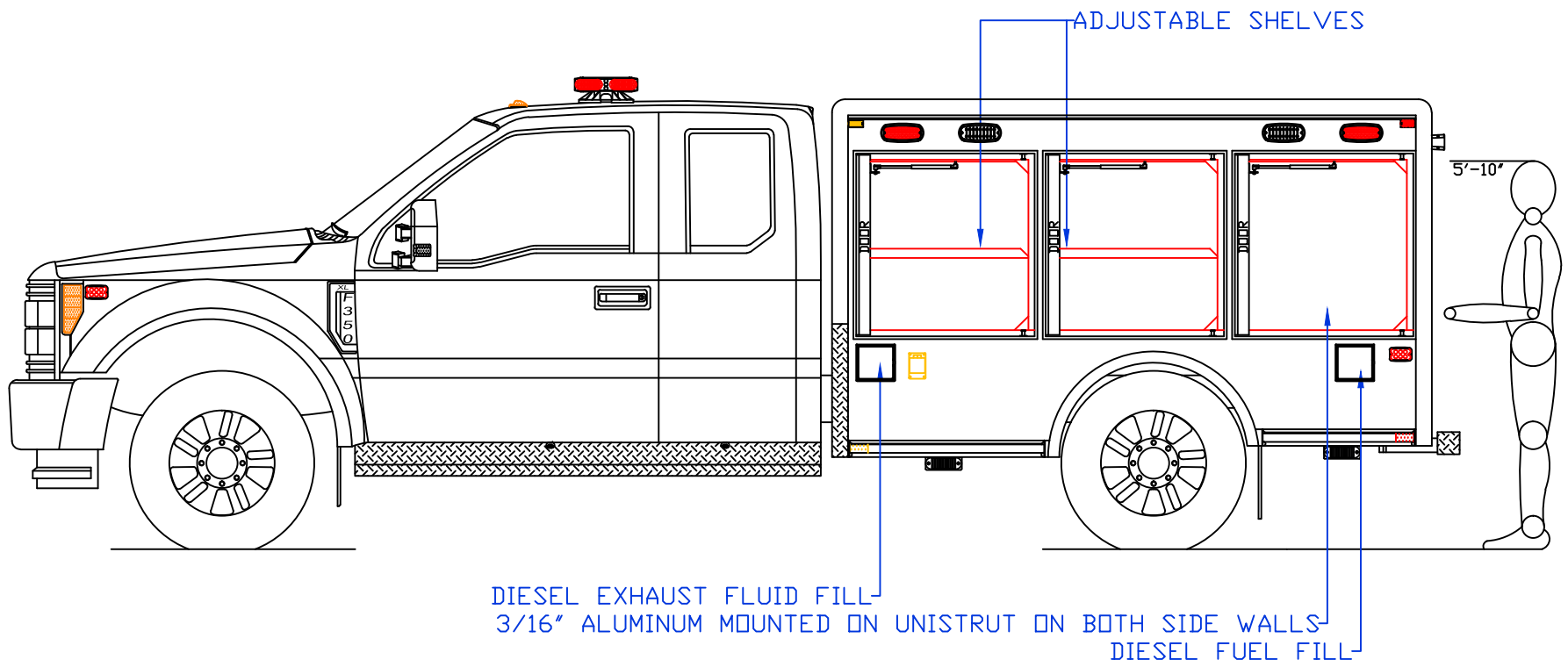

**Maintainer** [mcbfire.com](http://mcbfire.com)  
**Custom Bodies, Inc.**  
 909 South East Street  
 Rock Rapids, IA 51246  
 (800) 843-4288 Toll Free  
 (712) 472-4725

<b>CUSTOMER APPROVED BY:</b>		<b>PAINT CODE:</b>
VEHICLE TYPE: INVESTIGATIVE	CHASSIS: FORD F-350 SUPERCAB 4X4	BODY MAT'L: ALUMINUM
VIEW: STREETSIDE COMPARTMENT LAYOUT	BODY LENGTH: 108 1/8"	APPROVED BY:
SCALE: NTS	DATE: 9/26/2019	BODY STYLE:
DRAWN BY: NRW	DWG NO.: BARSTOWFIREDEPT	REVISION:

BARSTOW FIRE DEPARTMENT SQUAD

NOTE: ALL DIMENSIONS ARE APPROXIMATE

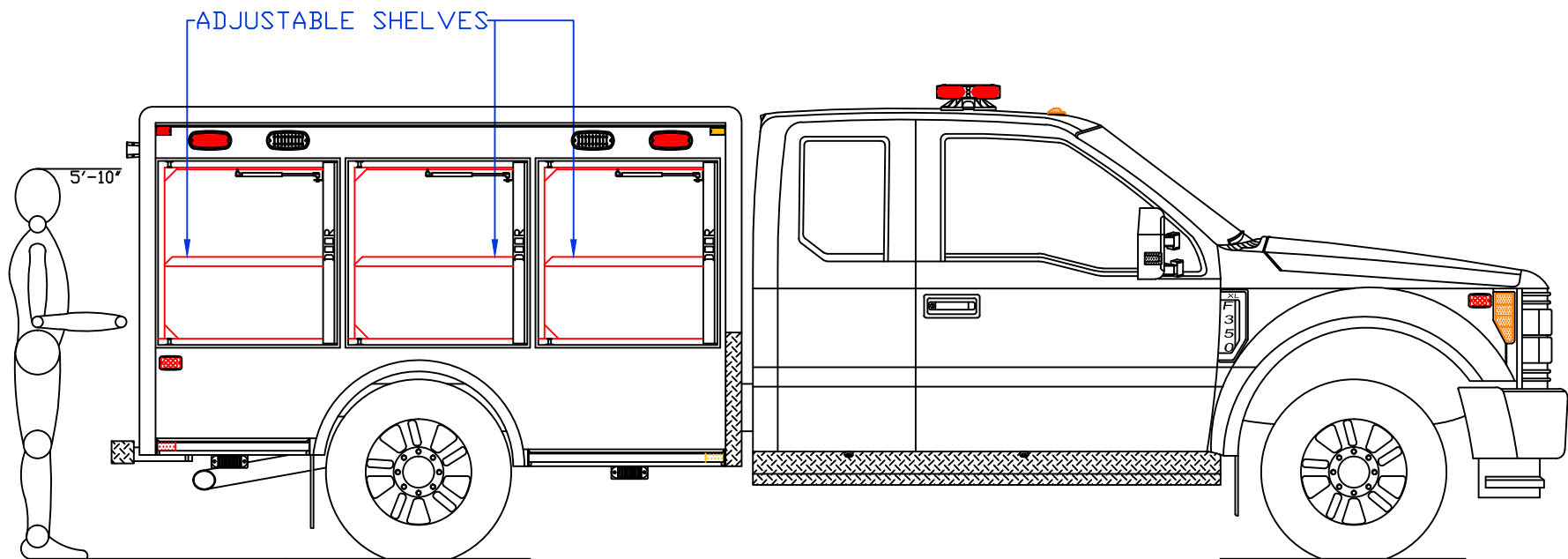

**Maintainer** [mcbfire.com](http://mcbfire.com)  
**Custom Bodies, Inc.**  
 909 South East Street (800) 843-4288 Toll Free  
 Rock Rapids, IA 51246 (712) 472-4725

<b>CUSTOMER APPROVED BY:</b>		<b>PAINT CODE:</b>
VEHICLE TYPE: INVESTIGATIVE	CHASSIS: FORD F-350 SUPERCAB 4X4	
VIEW: CURBSIDE COMPARTMENT LAYOUT	BODY MAT'L: ALUMINUM	
SCALE: NTS	BODY LENGTH: 108 1/8"	
DRAWN BY: NRW	APPROVED BY:	
DATE: 9/26/2019	BODY STYLE:	
DWG NO.: BARSTOWFIREDEPT	REVISION:	

BARSTOW FIRE DEPARTMENT SQUAD

NOTE: ALL DIMENSIONS ARE APPROXIMATE