

Maintainer Custom Bodies, Inc. mcbfire.com
 909 South East Street (800) 843-4288 Toll Free
 Rock Rapids, IA 51246 (712) 472-4725

CUSTOMER APPROVED BY:		PAINT CODE:
VEHICLE TYPE: RESCUE	CHASSIS: FORD F-550 CREW CAB 4X4	
VIEW: STREETSIDE	BODY MAT'L: ALUMINUM	
SCALE: NTS	BODY LENGTH: 140 1/4"	
DRAWN BY: NRW	APPROVED BY:	
DATE: 5/2/2018	BODY STYLE:	
DWG NO.: WALLEDLAKE	REVISION:	

PROPOSAL FOR: WALLEDLAKE RESCUE

NOTE: ALL DIMENSIONS ARE APPROXIMATE

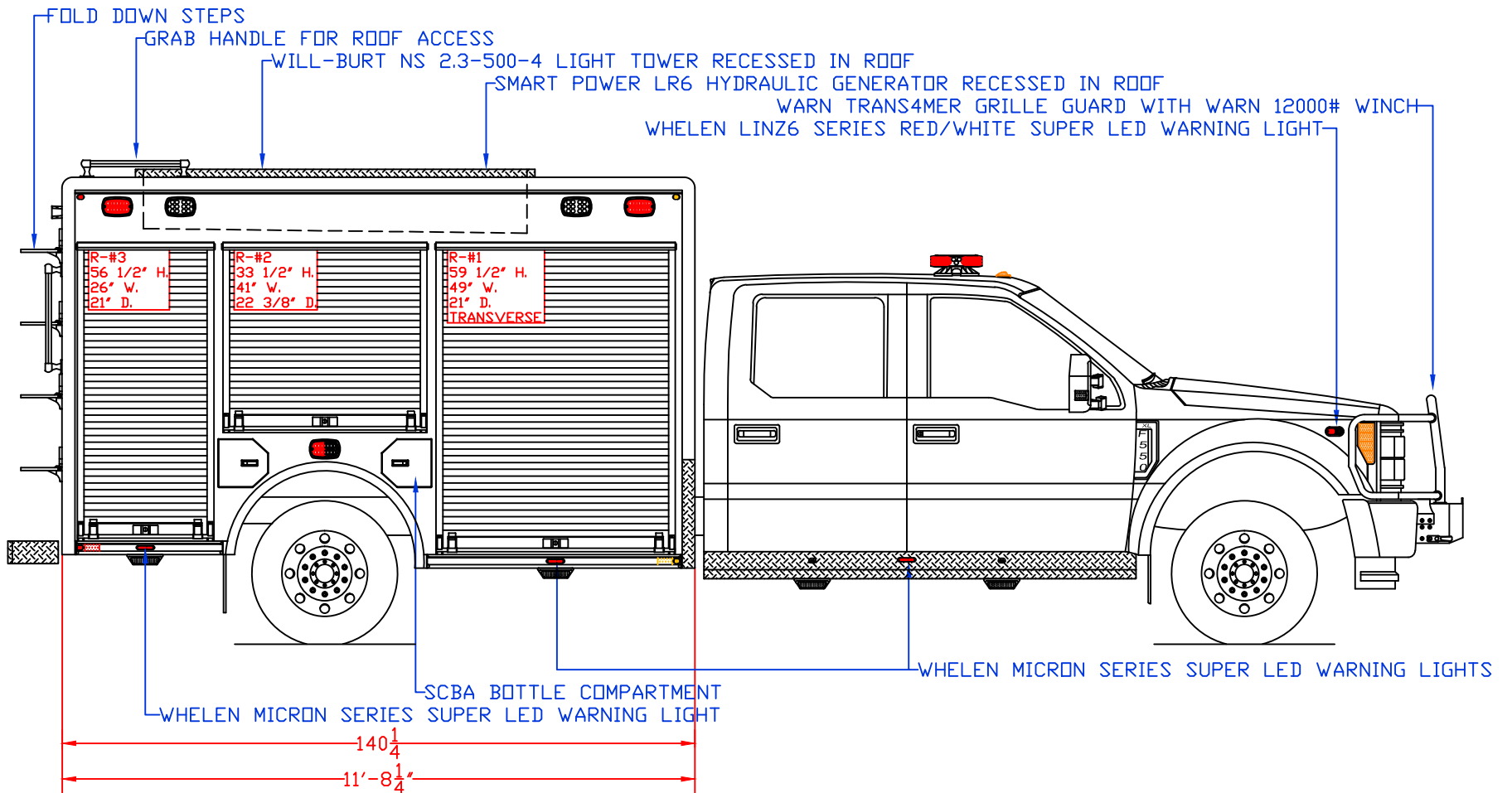

Maintainer *mcbfire.com*
Custom Bodies, Inc.
 909 South East Street (800) 843-4288 Toll Free
 Rock Rapids, IA 51246 (712) 472-4725

PROPOSAL FOR: WALLEDLAKE RESCUE

CUSTOMER APPROVED BY:		PAINT CODE:	
VEHICLE TYPE: RESCUE	CHASSIS: FORD F-550 CREW CAB 4X4		
VIEW: CURBSIDE	BODY MAT'L: ALUMINUM		
SCALE: NTS	BODY LENGTH: 140 1/4"		
DRAWN BY: NRW	APPROVED BY:		
DATE: 5/2/2018	BODY STYLE:		
DWG NO.: WALLEDLAKE	REVISION:		

NOTE: ALL DIMENSIONS ARE APPROXIMATE

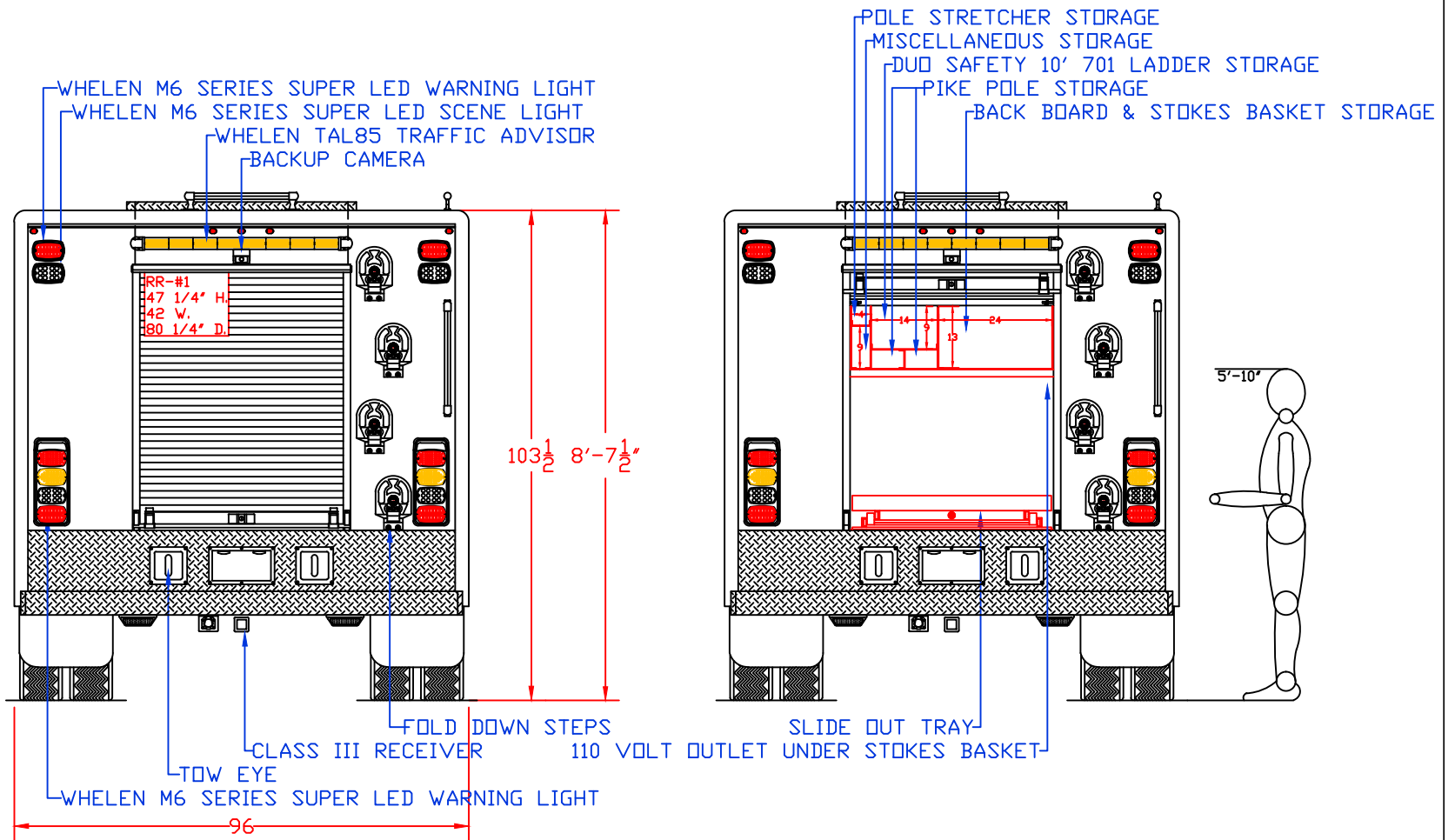

Maintainer Custom Bodies, Inc. mcbfire.com
 909 South East Street (800) 843-4288 Toll Free
 Rock Rapids, IA 51246 (712) 472-4725

PROPOSAL FOR: WALLEDD LAKE RESCUE

CUSTOMER APPROVED BY:		PAINT CODE:	
VEHICLE TYPE: RESCUE		CHASSIS: FORD F-550 CREW CAB 4X4	
VIEW: REAR & REAR COMPARTMENT LAYOUT		BODY MAT'L: ALUMINUM	
SCALE: NTS		BODY LENGTH: 140 1/4"	
DRAWN BY: NRW		APPROVED BY:	
DATE: 5/2/2018		BODY STYLE:	
DWG NO.: WALLEDDLAKE		REVISION:	

NOTE: ALL DIMENSIONS ARE APPROXIMATE

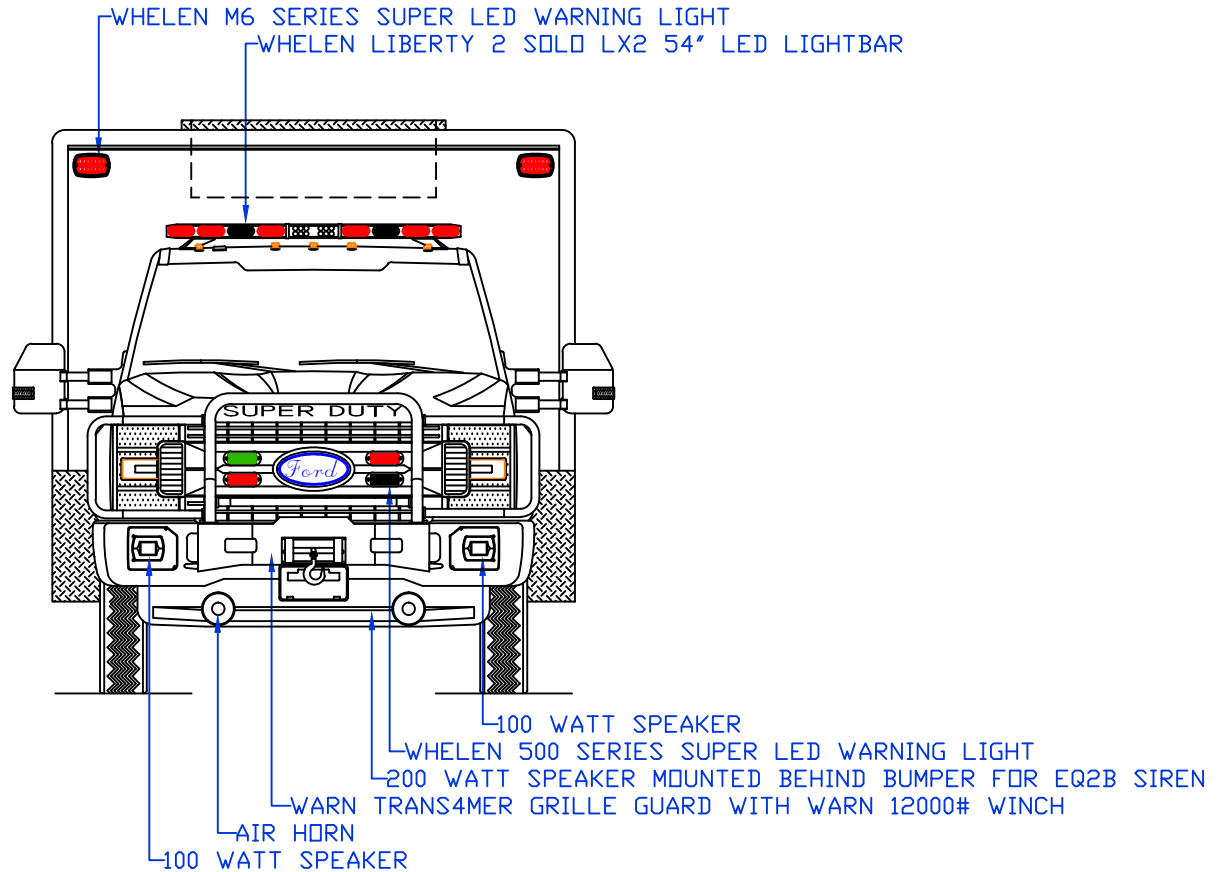

Maintainer *Custom Bodies, Inc.*
 909 South East Street (800) 843-4288 Toll Free
 Rock Rapids, IA 51246 (712) 472-4725

mcbfire.com

CUSTOMER APPROVED BY:		PAINT CODE:
VEHICLE TYPE: RESCUE	CHASSIS: FORD F-550 CREW CAB 4X4	
VIEW: FRONT	BODY MAT'L: ALUMINUM	
SCALE: NTS	BODY LENGTH: 140 1/4"	
DRAWN BY: NRW	APPROVED BY:	
DATE: 5/2/2018	BODY STYLE:	
DWG NO.: WALLEDLAKE	REVISION:	

PROPOSAL FOR: WALLEDLAKE RESCUE

NOTE: ALL DIMENSIONS ARE APPROXIMATE

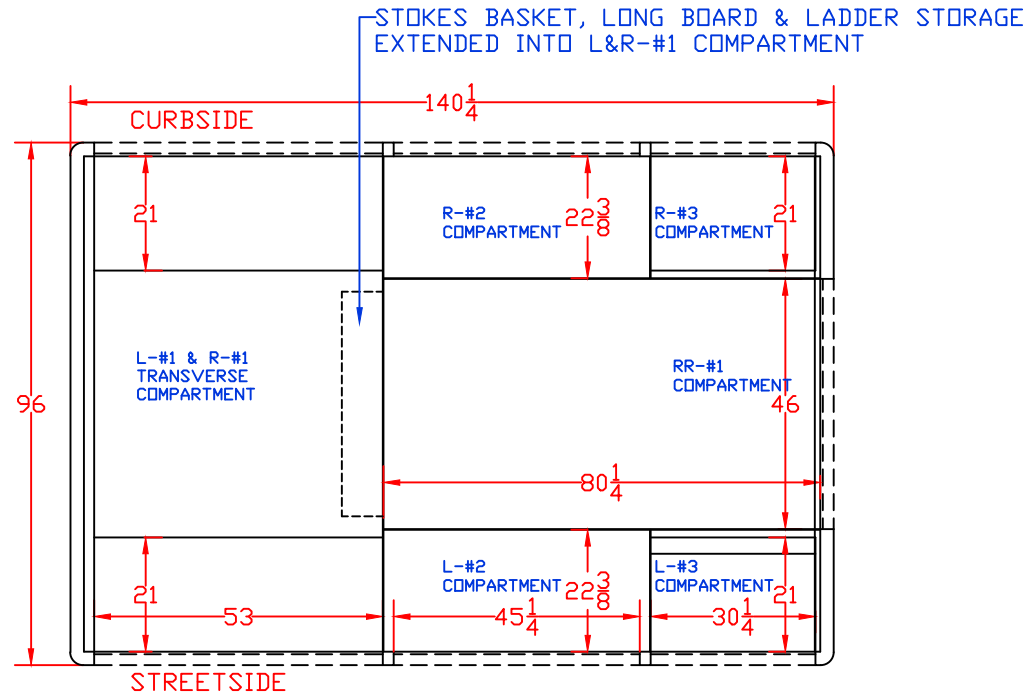

Maintainer Custom Bodies, Inc. mcbfire.com
 909 South East Street (800) 843-4288 Toll Free
 Rock Rapids, IA 51246 (712) 472-4725

PROPOSAL FOR: WALLED LAKE RESCUE

CUSTOMER APPROVED BY:		PAINT CODE:	
VEHICLE TYPE: RESCUE	CHASSIS: FORD F-550 CREW CAB 4X4	BODY MAT'L: ALUMINUM	
VIEW: TOP	BODY LENGTH: $140\frac{1}{4}$ "		
SCALE: NTS	APPROVED BY:		
DRAWN BY: NRW	BODY STYLE:		
DATE: 5/2/2018	REVISION:		
DWG NO.: WALLEDLAKE			

NOTE: ALL DIMENSIONS ARE APPROXIMATE

WILL-BURT NS 2.3-500-4 LIGHT TOWER RECESSED IN ROOF
 SMART POWER LR6 HYDRAULIC GENERATOR

FOLD DOWN STEPS

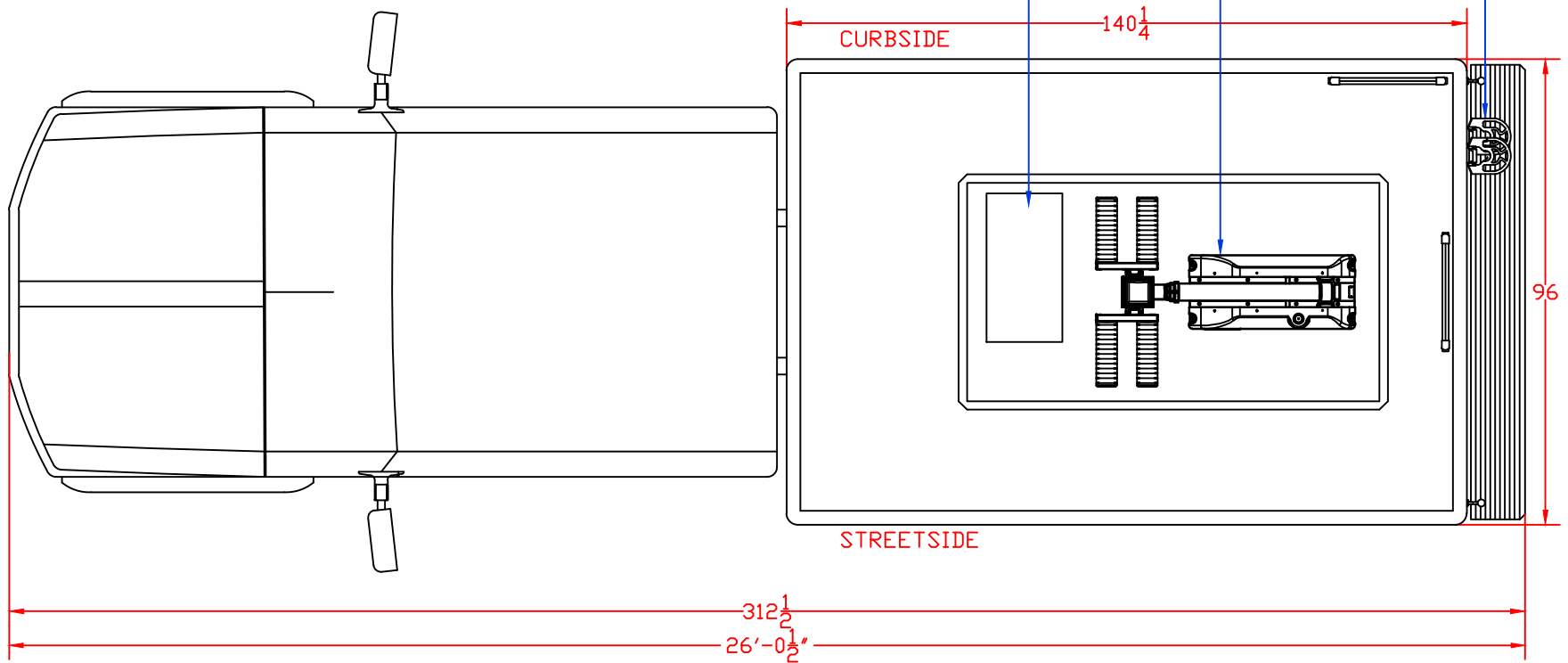

Maintainer Custom Bodies, Inc.
 909 South East Street (800) 843-4288 Toll Free
 Rock Rapids, IA 51246 (712) 472-4725

mcbfire.com

CUSTOMER APPROVED BY:		PAINT CODE:	
VEHICLE TYPE: RESCUE	CHASSIS: FORD F-550 CREW CAB 4X4		
VIEW: ROOF	BODY MAT'L: ALUMINUM		
SCALE: NTS	BODY LENGTH: 140 1/4"		
DRAWN BY: NRW	APPROVED BY:		
DATE: 5/2/2018	BODY STYLE:		
DWG NO.: WALLEDLAKE	REVISION:		

PROPOSAL FOR: WALLEDLAKE RESCUE

NOTE: ALL DIMENSIONS ARE APPROXIMATE

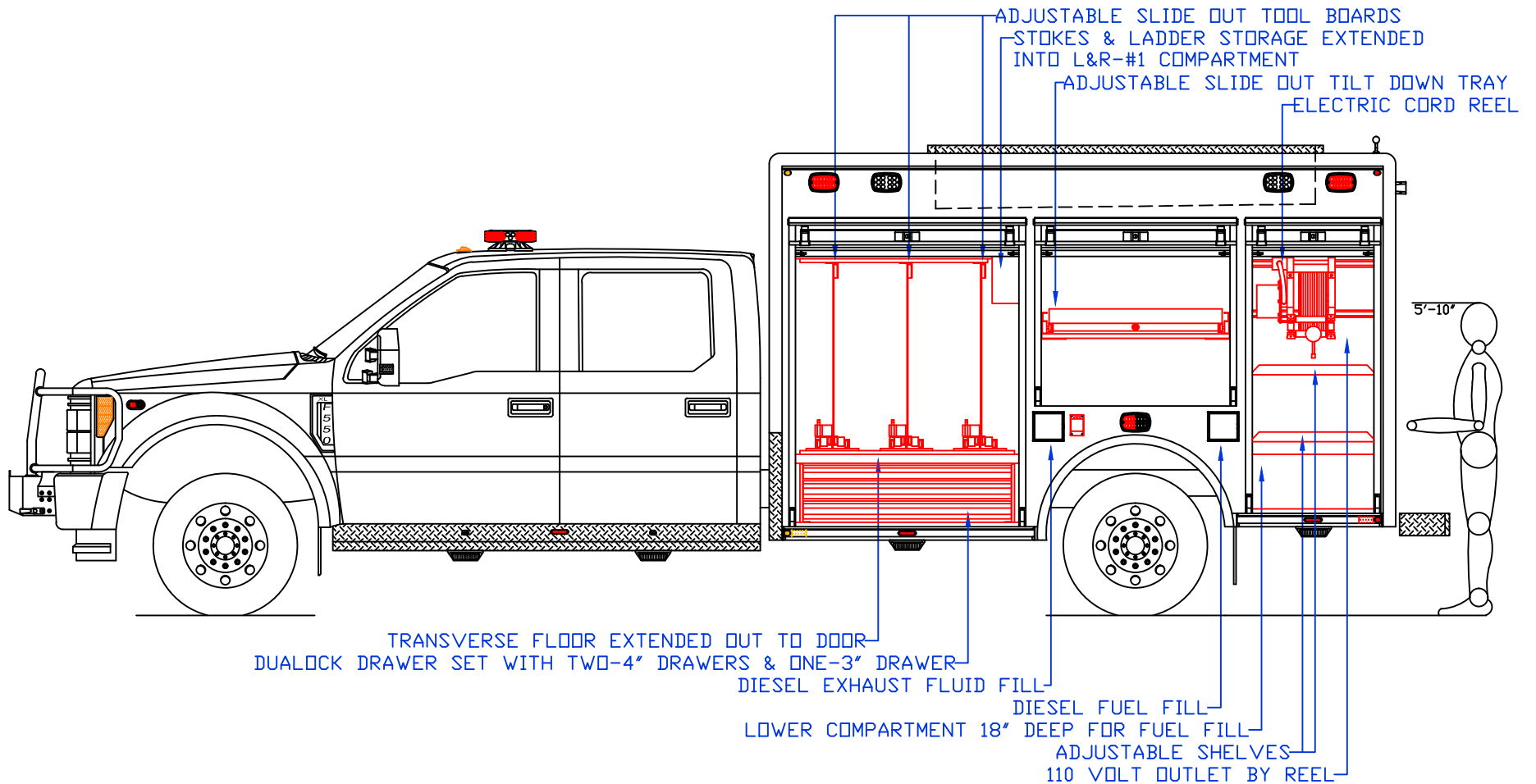

Maintainer *Custom Bodies, Inc.*
 909 South East Street (800) 843-4288 Toll Free
 Rock Rapids, IA 51246 (712) 472-4725

mcbfire.com

CUSTOMER APPROVED BY:

PAINT CODE:

VEHICLE TYPE: RESCUE

CHASSIS: FORD F-550 CREW CAB 4X4

VIEW: STREETSIDE COMPARTMENT LAYOUT

BODY MAT'L: ALUMINUM

SCALE: NTS

BODY LENGTH: 140 1/4"

DRAWN BY: NRW

APPROVED BY:

DATE: 5/2/2018

BODY STYLE:

DWG NO.: WALLEDLAKE

REVISION:

PROPOSAL FOR: WALLEDLAKE RESCUE

NOTE: ALL DIMENSIONS ARE APPROXIMATE

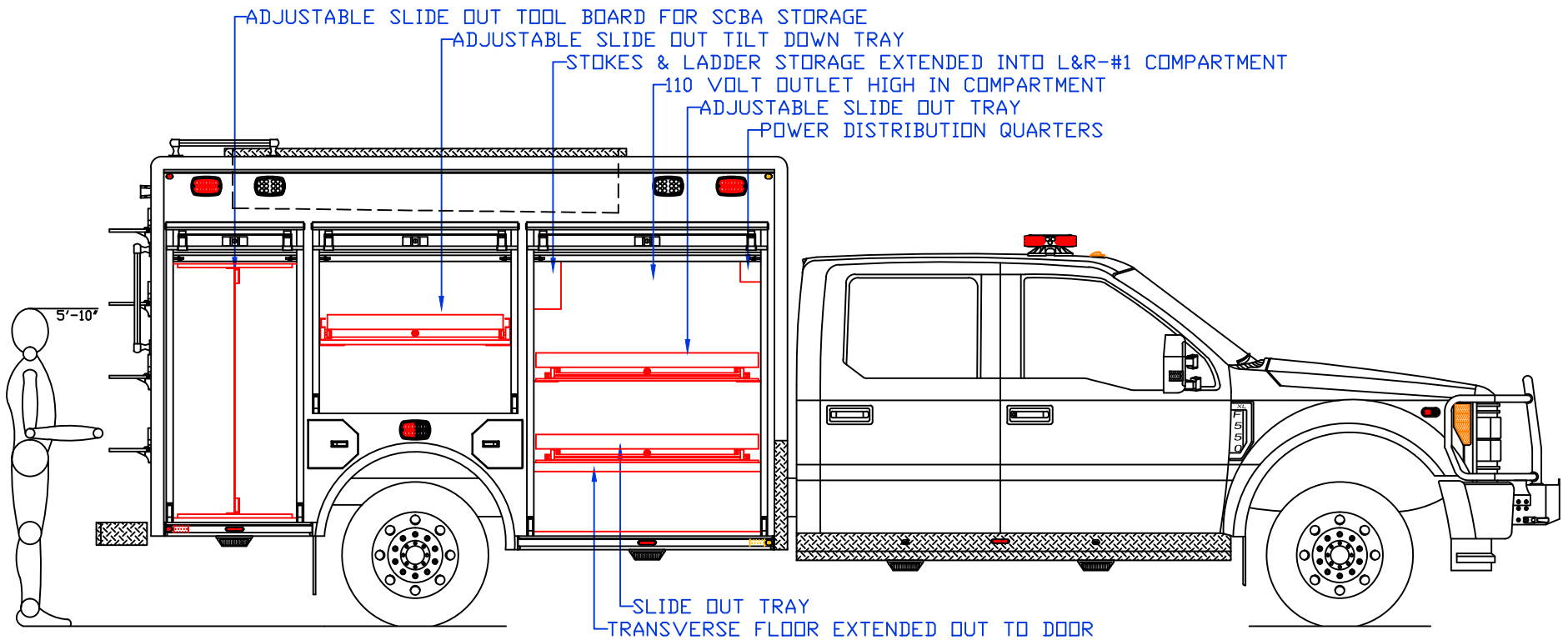

Maintainer *Custom Bodies, Inc.*
 909 South East Street (800) 843-4288 Toll Free
 Rock Rapids, IA 51246 (712) 472-4725

mcbfire.com

CUSTOMER APPROVED BY:		PAINT CODE:
VEHICLE TYPE: RESCUE	CHASSIS: FORD F-550 CREW CAB 4X4	
VIEW: CURBSIDE COMPARTMENT LAYOUT	BODY MAT'L: ALUMINUM	
SCALE: NTS	BODY LENGTH: 140 1/4"	
DRAWN BY: NRW	APPROVED BY:	
DATE: 5/2/2018	BODY STYLE:	
DWG NO.: WALLEDLAKE	REVISION:	

PROPOSAL FOR: WALLEDLAKE RESCUE

NOTE: ALL DIMENSIONS ARE APPROXIMATE